

Directional Coupler

Model: MDC10-010400



Microot Microwave co., Ltd.

1-10dB Directional Coupler



Features

- 1.Theoretical Insertion Loss not included in the Insertion Loss Parameter.
2. Multi-Octave bandwidth of working frequency range.
3. Superior phase balance and amplitude balance between any 2 ports.
4. Low VSWR and high Directivity.

Elec.Spec. "50Ω"

[Inquiry](#)

Freq. Range (GHz)	1-40
Nom.Coupling (dB) Limits	10±0.6
Main VSWR Max	1.7
Coupling VSWR Max	1.7
Insertion Loss (dB) Max	2.5
Directivity (dB) Max	10
CW Power (W) Max	20
Peak Power (KW) Max	3
Connector	2.92mm-F
Operating Temp. (°C)	-35 ~ +105
Storage Temp. (°C)	-55 ~ +125
Weight (g) Max	N/A

Outline Drawing Unit: mm

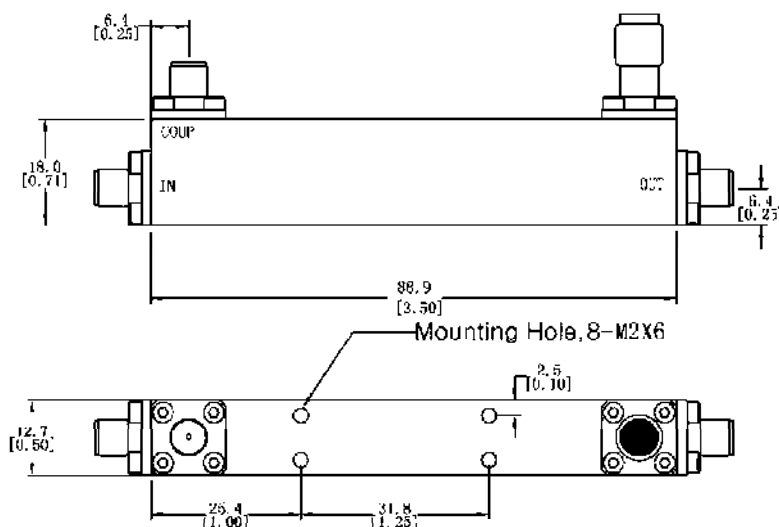

Add: #D505, Dahechang, No.511, Xingshi Rd, Western Section 1, 3rd Ringroad, Chengdu, CHINA
Tel: 86-28-85542308, Fax: 86-28-85007280, E-mail: info@mic-root.com, Website: www.mic-root.com